

2/2 way Diaphragm Valve, cast valve body, weld end and clamp connection, port connection DN4-50



Type 2031 with weld end connection

Type 2031 with clamp connection

- Hermetical separation of fluids from the operating mechanism by diaphragm
- Zero dead volume
- Various surface finishes
- Quality certifications / USP 

Type 2031 can be combined with...



Type 8697

Electrical position feedback

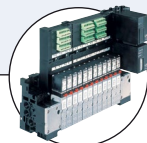

Type 8640/8644

Valve block



Type 6012/6014 P

Pilot valve



Type 8311

Pressure Sensor/ Switch

For process valves with decentralized automation see ELEMENT Type 2103 

The externally piloted diaphragm valve consists of a pneumatically operated piston actuator, a diaphragm and a 2-way valve housing made of investment cast stainless steel.

The standard material of the actuator is PPS. With its favourable flow characteristics and zero dead volume, the valve housing enables high flow capacities and a variety of applications to be realized.

Applications

- Water treatment
- Biotechnology
- Food industry

Technical data	
Port Connection	DN4 – 50
Body material	Cast stainless steel 316 L/1.4435
Actuator material	PPS (PA polyamide on request)
Pilot air ports	Stainless steel 1.4305
Diaphragm materials	EPDM (AD), PTFE/EPDM (EA), advanced PTFE/EPDM (EU) and FKM (FF) on request
Medium	Neutral gases and liquids, high purity, sterile, aggressive or abrasive fluids
Viscosity	up to viscous
Surface finish	(average surface finish) internal mechanical polished (external cast surface) Ra ≤ 0.8 µm internal electro polished (external cast surface electro polished) (more on request) Ra ≤ 0.6 µm
Media temperature	EPDM (AD) -10 bis + 130 °C (steam sterilisation + 150 °C for 60 min) PTFE/EPDM (EA) -10 to + 130 °C (steam sterilisation + 140 °C for 60 min) advanced PTFE/EPDM (EU) -5 to + 143 °C (steam sterilisation + 150 °C for 60 min) FKM (FF) 0 to + 130 °C (not recommended for steam)
Ambient temperature	PPS actuator size ≤ 80 mm +5 to 140 °C PPS actuator size 100 mm, 125 mm +5 to 90 °C (briefly up to + 140 °C) PA actuator size ≤ 125 mm (on request) -10 to + 60 °C PA actuator size ≥ 175 mm -10 to + 50 °C

Content



Valve specifications

Type 2031 cast

Technical data & ordering info.

p. 1-8



System spec. On/Off CLASSIC

Type 8801-DB

Ordering info. & technical data

p. 9-12

Request for quotation

Type 8801-DB

p. 13

Technical data, *continued*

Control medium	neutral gases; air
Pilot pressure max.	max. 7 bar, see table p. 2
Port connections	EN ISO 1127/ISO 4200, DIN 11850 S0 to S3, SMS 3008 ISO 2852/SMS 3017, DIN 32676, BS 4825 on request DIN 11851, SMS 1145
Weld end acc. Clamp acc. Sterile threaded ends	
Installation	As required, preferably with actuator in upright position

K_v values

Port connection DN	Orifice (diaphragm size)	K _v value water ¹⁾	Actuator size Ø	Pilot pressure (bar)		Max. operating pressure for seal material [bar]		Weight [kg]
				min.	max.	EPDM, FKM	PTFE/EPDM, advanced PTFE/EPDM	
4/6	8	0.8	40	5.0	7	10	10	0.4
8	8	1.0	40	5.0	7	10	10	0.4
10	8	1.0	40	5.0	7	10	10	0.4
15	15	4.0	50	5.0	7	8.5	5	0.7
		4.5	63	5.0	7	10	10	0.9
20	20	7.0	63	5.5	7	10	5	1.3
		7.5	80	5.0	7	10	10	2.0
25	25	12.0	63	5.0	7	3	–	2.2
		12.0	80	5.5	7	10	7.5	2.2
32	32	30.0	100	5.5	7	6.5	6	4.2
		30.5	125	5.5	7	–	10	5.7
40	40	30.0	100	5.5	7	6.5	–	4.2
		30.5	125	5.5	7	10	10	5.7
50	50	51.5	100	5.5	7	4.5	2.5	5.9
		51.5	125	5.5	7	6	7	7.6

¹⁾ Measured at +20 °C, 1 bar pressure at valve inlet and free outlet.

Pressure values (bar): Gauge pressures with respect to the prevailing atmospheric pressure.

Remark:

For low operating pressures we recommend reduced spring versions.

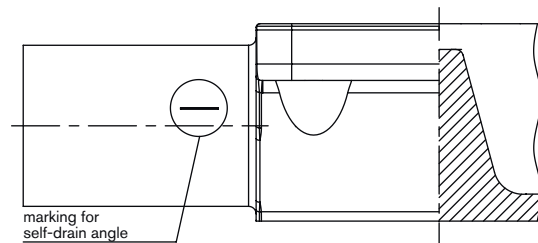
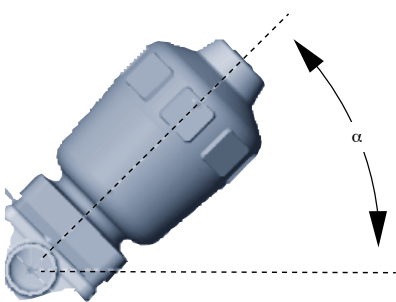
Installation for self-draining operation

$\alpha = 15$ up to 35° (Marking must face upwards, 12 o'clock position)
plus 1° to 5° inclination to the pipe axis.
Drain marks permanently marked on both sides of the valve body
show the correct mounting position to optimise drain ability.

Materials

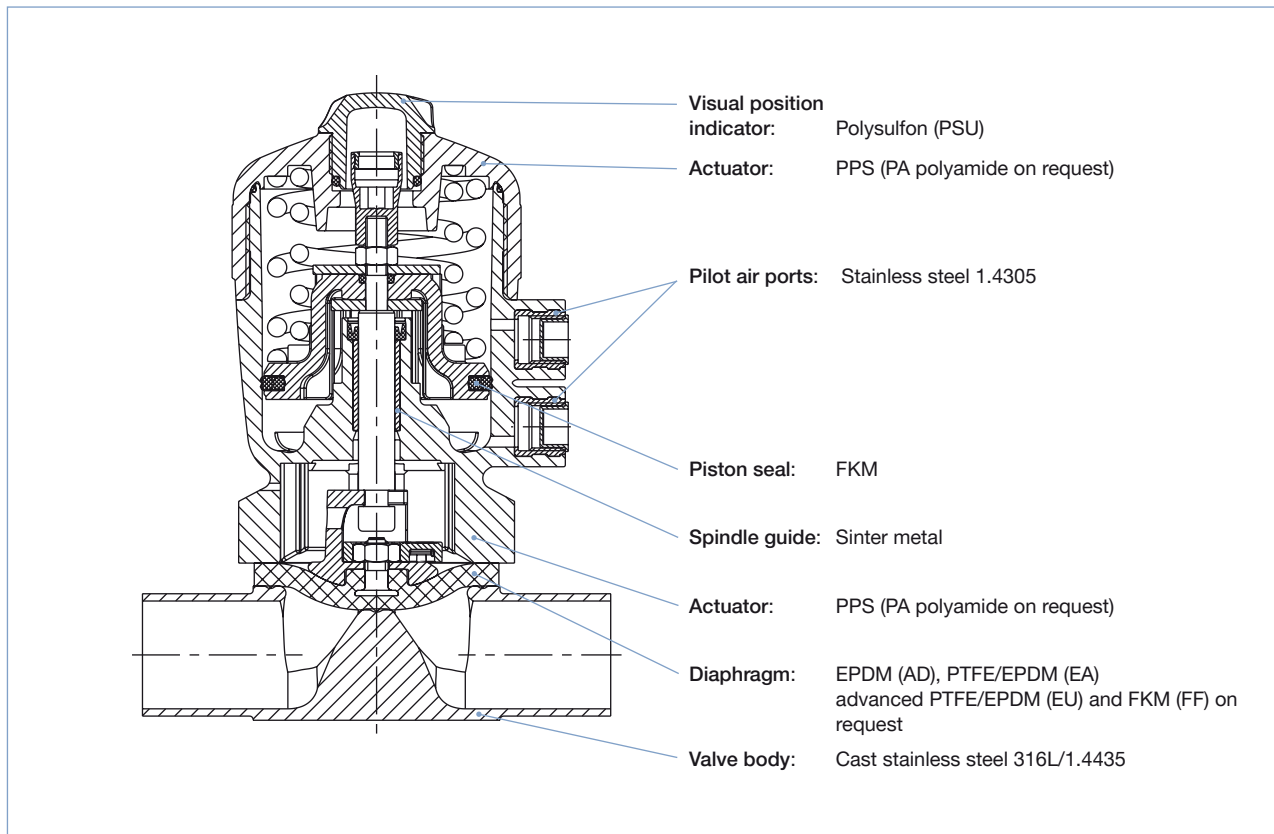

Approvals

Suitability for foodstuffs / sterile applications













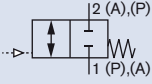

































- The composition of the EPDM (AD), PTFE/EPDM (EA) and advanced PTFE (EU) diaphragms corresponds to the Code of Federal Regulations, published by the FDA (Food and Drug Administration, USA).



- The composition of the EPDM (AD), PTFE/EPDM (EA) and advanced PTFE (EU) diaphragms is suitable for the application with food and beverage (acc. to EC-Regulation 1935/2004/EC)
- The composition of the EPDM (AD), PTFE/EPDM (EA) und advanced PTFE (EU) diaphragms are approved acc. USP Class VI
- Approval according to TA-air (Port size DN4 – 50)

Ordering chart for valves (other versions on request)

Body with weld end

	Port connection DN		Orifice (Diaphragm size) [mm]	External Ø [mm]	K _v value water [m³/h]	Actuator size Ø [mm]	Pilot pressure [bar]	Max. operating pressure [bar]	Article no. mech. polished, Ra ≤ 0.8 µm	Article no. electro polished, Ra ≤ 0.6 µm
	[mm]	[inch]								
Control function A  Pneumatically operated on / off valve, bidirectional, normally closed by spring force	Acc. EN ISO 1127/ ISO 4200									
	Diaphragm material EPDM (AD)									
	8	¼"	8	13.5	1.0	40	5.0–7	10	248872 	265953 
	10	⅜"	8	17.2	1.0	40	5.0–7	10	291113 	265954 
	15	½"	15	21.3	4.0	50	5.0–7	8.5	291128 	291125 
	20	¾"	20	26.9	7.0	63	5.5–7	10	248875 	291170 
	25	1"	25	33.7	12.0	80	5.5–7	10	291187 	291185 
	32	1¼"	40	42.4	30.0	100	5.5–7	6.5	248873 	291222 
	40	1½"	40	48.3	30.0	100	5.5–7	6.5	291225 	291227 
	50	2"	50	60.3	51.5	125	5.5–7	8	291246 	291250 
	Diaphragm material PTFE/EPDM (EA)									
	8	¼"	8	13.5	1.0	40	5.0–7	10	441952 	441953 
	10	⅜"	8	17.2	1.0	40	5.0–7	10	441963 	441964 
	15	½"	15	21.3	4.5	63	5.0–7	10	441967 	441968 
	20	¾"	20	26.9	7.5	80	5.0–7	10	441971 	441972 
	25	1"	25	33.7	12.0	80	5.5–7	7.5	441975 	441976 
	32	1¼"	40	42.4	30.5	125	5.5–7	10	550766 	554965 
	40	1½"	40	48.3	30.5	125	5.5–7	10	441979 	441980 
	50	2"	50	60.3	51.5	125	5.5–7	7	441983 	441984 
	Acc. SMS 3008									
	Diaphragm material EPDM (AD)									
	25	1"	25	25.0	12.0	80	5.5–7	10	246542 	291206 
	40	1½"	40	38.0	30.0	100	5.5–7	6.5	291231 	291230 
	50	2"	50	51.0	51.5	125	5.5–7	8	318626 	291252 
	Diaphragm material PTFE/EPDM (EA)									
	25	1"	25	25.0	12.0	80	5.5–7	7.5	442061 	442062 
	40	1½"	40	38.0	30.5	125	5.5–7	10	442065 	442066 
	50	2"	50	51.0	51.5	125	5.5–7	7	442069 	442070 

Port connection size equals the orifice diaphragm size except for port connection 32 mm. At port connection 32 mm the orifice diaphragm size equals 40 mm.











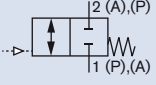





















Further versions on request

 **Additional**
Versions with reduced spring force

 **Material**
Diaphragms for steam sterilization advanced PTFE / EPDM (EU) and FKM (FF)

Ordering chart for valves (other versions on request)

Body with weld end, cont.

	Port connection DN		Orifice (Diaphragm size) [mm]	External Ø [mm]	K _v value water [m³/h]	Actuator size Ø [mm]	Pilot pressure [bar]	Max. operating pressure [bar]	Article no. mech. polished, Ra ≤ 0.8 µm	Article no. electro polished, Ra ≤ 0.6 µm
	[mm]	[inch]								
Control function A  Pneumatically operated on / off valve, bidirectional, normally closed by spring force	Acc. DIN 11850									
	Diaphragm material EPDM (AD)									
	Series 0									
	4	-	8	6.0	0.8	40	5.0-7	10	319864 	319865 
	6	-	8	8.0	0.8	40	5.0-7	10	291093 	319866 
	Series 2									
	10	3/8"	8	13.0	1.0	40	5.0-7	10	291116 	291118 
	15	1/2"	15	19.0	4.0	50	5.0-7	8.5	291152 	291154 
	20	3/4"	20	23.0	7.0	63	5.5-7	10	291172 	291174 
	25	1"	25	29.0	12.0	80	5.5-7	10	291209 	318561 
	40	1 1/2"	40	41.0	30.0	100	5.5-7	6.5	318604 	291232 
	50	2"	50	53.0	51.5	125	5.5-7	8	318630 	318631 
	Diaphragm material PTFE/EPDM (EA)									
	Series 0									
	4	-	8	6.0	0.8	40	5.0-7	10	443777 	443778 
	6	-	8	8.0	0.8	40	5.0-7	10	443781 	443782 
	Series 2									
	10	3/8"	8	13.0	1.0	40	5.0-7	10	441778 	441779 
	15	1/2"	15	19.0	4.5	63	5.0-7	10	441794 	441795 
	20	3/4"	20	23.0	7.5	80	5.0-7	10	441866 	441867 
	25	1"	25	29.0	12.0	80	5.5-7	7.5	441885 	441886 
	40	1 1/2"	40	41.0	30.5	125	5.5-7	10	441901 	441902 
	50	2"	50	53.0	51.5	125	5.5-7	7	441956 	441957 











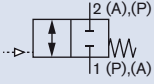













































i Further versions on request

> Additional
Versions with reduced spring force

Material
Diaphragms for steam sterilization advanced PTFE / EPDM (EU) and FKM (FF)

Ordering chart for valves (other versions on request)

Body with clamp connection

	Port connection DN		Orifice (Diaphragm size) [mm]	External Ø [mm]	K _v value water [m ³ /h]	Actuator size Ø [mm]	Pilot pressure [bar]	Max. operating pressure [bar]	Article no. mech. polished, Ra ≤ 0.8 µm	Article no. electro polished, Ra ≤ 0.6 µm
	[mm]	[inch]								
Control function A  Pneumatically operated on / off valve, bidirectional, normally closed by spring force	Acc. ISO 2852 – SMS 3017									
	Diaphragm material EPDM (AD)									
	25	1"	25	50.5	12.0	80	5.5–7	10	291217 	291215 
	40	1½"	40	50.5	30.0	100	5.5–7	6.5	291241 	291240 
	50	2"	50	64.0	51.5	125	5.5–7	8	312840 	291261 
	Diaphragm material PTFE/EPDM (EA)									
	25	1"	25	50.5	12.0	80	5.5–7	7.5	442076 	442077 
	40	1½"	40	50.5	30.5	125	5.5–7	10	442080 	442081 
	50	2"	50	64.0	51.5	125	5.5–7	7	442084 	442085 
	Acc. DIN 32676									
	Diaphragm material EPDM (AD)									
	15	½"	15	34.0	4.0	50	5.0–7	8.5	291157 	318483 
	20	¾"	20	34.0	7.0	63	5.5–7	10	291176 	291177 
	25	1"	25	50.5	12.0	80	5.5–7	10	291563 	291211 
	40	1½"	40	50.5	30.0	100	5.5–7	6.5	291237 	291238 
	50	2"	50	64.0	51.5	125	5.5–7	8	318633 	291258 
	Diaphragm material PTFE/EPDM (EA)									
	15	½"	15	34.0	4.5	63	5.0–7	10	442041 	442042 
	20	¾"	20	34.0	7.5	80	5.0–7	10	442045 	442046 
	25	1"	25	50.5	12.0	80	5.5–7	7.5	442049 	442050 
	40	1½"	40	50.5	30.5	125	5.5–7	10	442053 	442054 
	50	2"	50	64.0	51.5	125	5.5–7	7	442057 	442058 
	Acc. BS 4825									
	Diaphragm material EPDM (AD)									
	8	¼"	8	25.0	1.0	40	5.0–7	10	291104 	291106 
	10	⅜"	8	25.0	1.0	40	5.0–7	10	291107 	291120 
	15	½"	15	25.0	4.0	50	5.0–7	8.5	291158 	291160 
	25	1"	25	50.5	12.0	80	5.5–7	10	291213 	291212 
	40	1½"	40	50.5	30.0	100	5.5–7	6.5	291239 	246801 
	50	2"	50	64.0	51.5	125	5.5–7	8.0	320524 	291259 
Diaphragm material PTFE/EPDM (EA)										
8	⅜"	8	25.0	1.0	40	5.0–7	10	441987 	441988 	
10	½"	8	25.0	1.0	40	5.0–7	10	441991 	441992 	
15	¾"	15	25.0	4.5	63	5.0–7	10	441995 	441996 	
25	1"	25	50.5	12.0	80	5.5–7	7.5	441999 	442000 	
40	1½"	40	50.5	30.5	125	5.5–7	10	442003 	442004 	
50	2"	50	64.0	51.5	125	5.5–7	7.0	442007 	442008 	

DTS 1000010978 EN Version: Z Status: RL (released | freigegeben | valide) printed: 11.02.2020

i Further versions on request

> Additional
Versions with reduced spring force

Material
Diaphragms for steam sterilization advanced PTFE / EPDM (EU) and FKM (FF)

Dimensions [mm]

Body with weld end

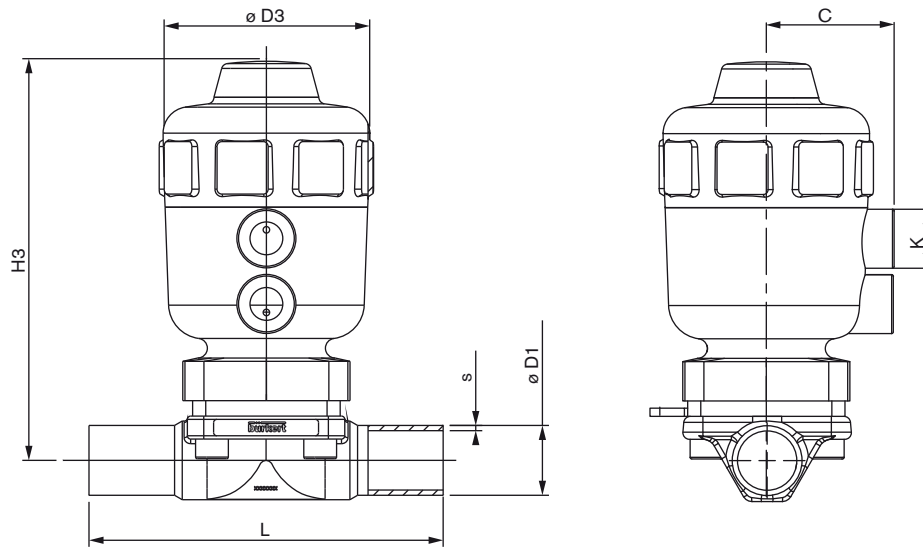

Port connection		Actuator size									
[mm]	[inch]	Ø	C	K	L	H3	ØD3	ØD1	s	ØD1	s
Acc. EN ISO 1127/ISO 4200 and SMS 3008								EN ISO 1127/ISO 4200		SMS 3008	
8	1/4"	40	34	G 1/8	90.0	100.0	53.0	13.5	1.6	-	-
10	3/8"	40	34	G 1/8	90.0	100.0	53.0	17.2	1.6	-	-
15	1/2"	50	39	G 1/8	110.0	121.0	64.0	21.3	1.6	-	-
		63	52	G 1/4	110.0	138.0	80.0	21.3	1.6	-	-
20	3/4"	63	52	G 1/4	119.0	148.0	80.0	26.9	1.6	-	-
		80	60	G 1/4	119.0	174.0	101.0	26.9	1.6	-	-
25	1"	63	52	G 1/4	129.0	157.0	80.0	33.7	2.0	25.0	1.2
		80	60	G 1/4	129.0	177.0	101.0	33.7	2.0	25.0	1.2
32	1 1/4"	100	73	G 1/4	161.0	233.0	127.0	42.4	2.0	-	-
		125	86	G 1/4	161.0	272.0	153.0	42.4	2.0	-	-
40	1 1/2"	100	73	G 1/4	161.0	233.0	127.0	48.3	2.0	38.0	1.2
		125	86	G 1/4	161.0	272.0	153.0	48.3	2.0	38.0	1.2
50	2"	100	73	G 1/4	192.0	244.0	127.0	60.3	2.0	51.0	1.2
		125	86	G 1/4	192.0	278.0	153.0	60.3	2.0	51.0	1.2
Acc. to DIN 11850								DIN 11850			
Series 0											
4	-	40	34	G 1/8	90.0	100.0	53.0	6.0	1.0		
6	-	40	34	G 1/8	90.0	100.0	53.0	8.0	1.0		
Series 2											
10	3/8"	40	34	G 1/8	90.0	100.0	53.0	13.0	1.5		
15	1/2"	50	39	G 1/8	110.0	121.0	64.0	19.0	1.5		
		63	52	G 1/4	110.0	138.0	80.0	19.0	1.5		
20	3/4"	63	52	G 1/4	119.0	148.0	80.0	23.0	1.5		
		80	60	G 1/4	119.0	174.0	101.0	23.0	1.5		
25	1"	63	52	G 1/4	129.0	157.0	80.0	29.0	1.5		
		80	60	G 1/4	129.0	177.0	101.0	29.0	1.5		
40	1 1/2"	100	73	G 1/4	161.0	233.0	127.0	41.0	1.5		
		125	86	G 1/4	161.0	272.0	153.0	41.0	1.5		
50	2"	100	73	G 1/4	192.0	244.0	127.0	53.0	1.5		
		125	86	G 1/4	192.0	278.0	153.0	53.0	1.5		

Dimensions [mm]

Body with clamp connection

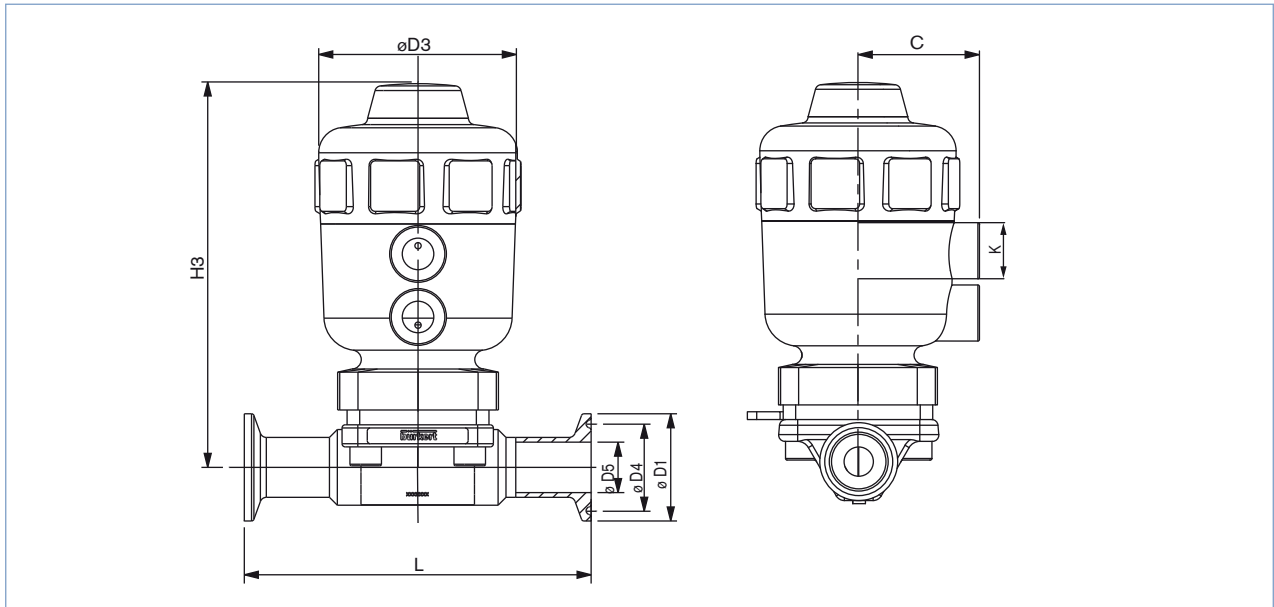

Port connection		Actuator size										
[mm]	[inch]	Ø	C	K	L	H3	ØD3	ØD1	ØD4	ØD5	ØD5	
Acc. ISO 2852/SMS 3017 and SMS 3008											ISO 2852	DIN 32676
15	½"	50	39	G ⅛	110.0	121.0	64.0	34.0	27.5	–	16.0	
		63	52	G ¼	110.0	138.0	80.0	34.0	27.5	–	16.0	
20	¾"	63	52	G ¼	119.0	148.0	80.0	34.0	27.5	–	20.0	
		80	60	G ¼	119.0	174.0	101.0	34.0	27.5	–	20.0	
25	1"	63	52	G ¼	129.0	157.0	80.0	50.5	43.5	22.6	26.0	
		80	60	G ¼	129.0	177.0	101.0	50.5	43.5	22.6	26.0	
40	1½"	100	73	G ¼	161.0	233.0	127.0	50.5	43.5	35.6	38.0	
		125	86	G ¼	161.0	272.0	153.0	50.5	43.5	35.6	38.0	
50	2"	100	73	G ¼	192.0	244.0	127.0	64.0	56.5	48.6	50.0	
		125	86	G ¼	192.0	278.0	153.0	64.0	56.5	48.6	50.0	
Acc. BS 4825											BS 4825	
8	⅜"	40	34	G ⅛	89.0	100.0	53.0	25.0	20.22	7.1		
10	½"	40	34	G ⅛	89.0	100.0	53.0	25.0	20.22	10.3		
15	¾"	50	39	G ⅛	102.0	121.0	64.0	25.0	20.22	16.7		
		63	52	G ¼	102.0	138.0	80.0	25.0	20.22	16.7		
25	1"	63	52	G ¼	114.0	157.0	80.0	50.5	43.5	22.2		
		80	60	G ¼	114.0	177.0	101.0	50.5	43.5	22.2		
40	1½"	100	73	G ¼	140.0	233.0	127.0	50.5	43.5	34.9		
		125	86	G ¼	140.0	272.0	153.0	50.5	43.5	34.9		
50	2"	100	73	G ¼	159.0	244.0	127.0	64.0	56.5	47.6		
		125	86	G ¼	159.0	278.0	153.0	64.0	56.5	47.6		

Ordering information for valve system On/Off CLASSIC Type 8801-DB

An **diaphragm valve Type 2031** can be combined with the **feedback Type 8697** to form a **valve system On/Off CLASSIC**.

The valve system On/Off CLASSIC is composed of:

- a feedback **Type 8697** (see separate datasheet) 
- an diaphragm valve **Type 2031** (see ordering chart p. 6)

For the configuration of further valve systems please use the "Request for quotation" on p. 11 – 12.
You order two components and receive a complete assembled and certified valve.



Electrical position feedback

More info.



Type 8697

Actuator size 40...225

The position feedback Type 8697 is designed for integrated mounting on CLASSIC series 20XX process valves suiting the requirements of hygienic process environment Mechanical or inductive limit switches register the position of the valve.

Features

- Compact design
- LED position indicator
- Mechanical or inductive limit switches for end position registering
- Easy to clean chemically resistant housing featuring IP65 / IP67, 4X Rating
- Optional intrinsically safe version acc. to ATEX

Benefits

- Easy and quick installation
- High level of signal reliability thanks to self adjusting limit switches
- Signal safety through the automatic adjustment of the limit switches
- Minimised space requirement in the plant piping for more flexibility in plant design

Click on the orange box „More info“... you will come to our website for the resp. product where you can download the data sheet.

Dimensions for valve system On/Off CLASSIC Type 8801-DB [mm]

Dimensions valve system On/Off CLASSIC Type 8801-DB with electrical feedback Type 8697

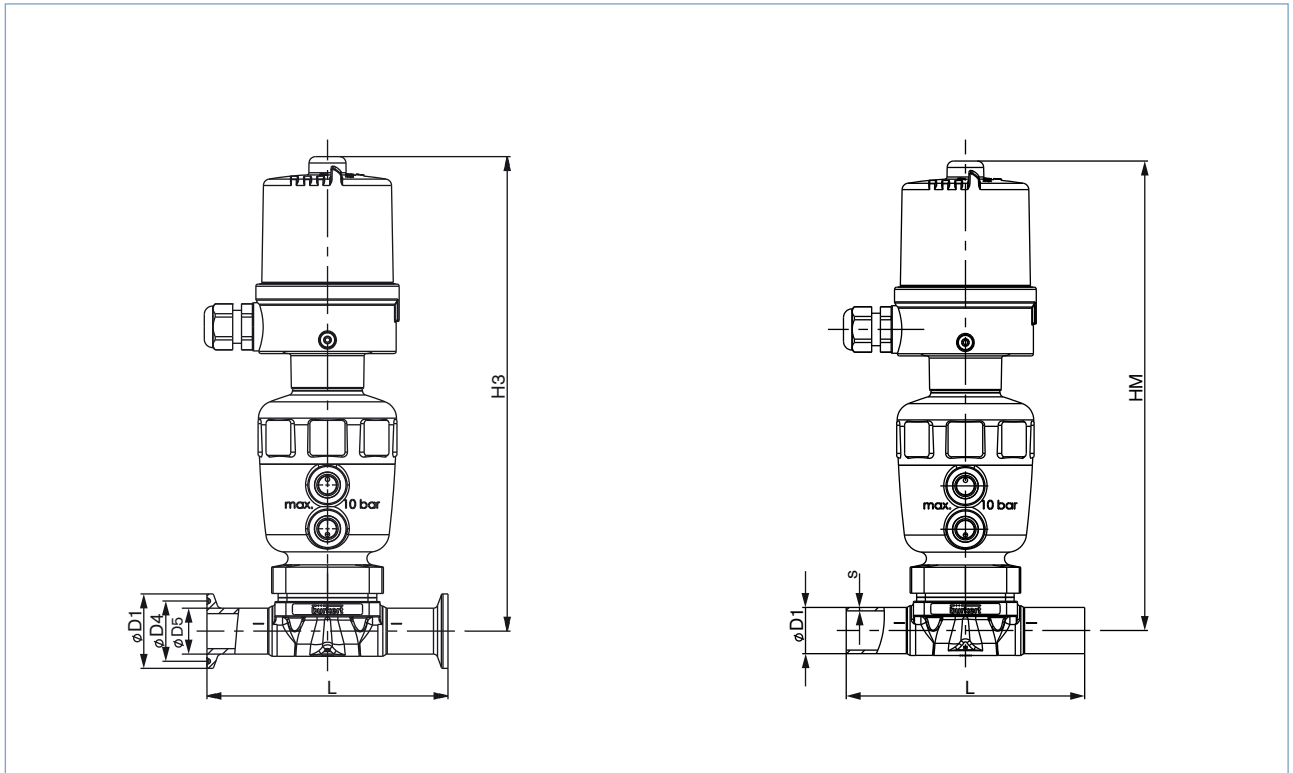

Port connection [mm]	Actuator size [mm]	Connection [mm]																													
		Weld end EN ISO 1127/ ISO 4200						SMS 3008						Clamp ISO 2852/ SMS 3107						DIN 32676						BS 4825					
		HM	L	ØD1	s	HM	L	ØD1	s	HM	L	ØD1	ØD4	ØD5	HM	L	ØD1	ØD4	ØD5	HM	L	ØD1	ØD4	ØD5							
8	40	185.9	90	13.5	1.6	-	-	-	-	-	-	-	-	-	-	-	-	-	-	-	-	-	-	185.9	89	25	20.22	7.1			
10	40	185.9	90	17.2	1.6	-	-	-	-	-	-	-	-	-	-	-	-	-	-	-	-	-	-	185.9	89	25	20.22	10.3			
15	50	216.9	110	21.3	1.6	-	-	-	-	-	-	-	-	-	215.9	110	34	27.5	16	215.9	102	25	20.22	16.7	-	-	-	-	-		
15	63	233.9	110	21.3	1.6	-	-	-	-	-	-	-	-	-	232.9	110	34	27.5	16	232.9	102	25	20.22	16.7	-	-	-	-	-		
20	63	243.9	119	26.9	1.6	-	-	-	-	-	-	-	-	-	242.9	119	34	27.5	20	-	-	-	-	-	-	-	-	-	-	-	
20	80	269.9	119	26.9	1.6	-	-	-	-	-	-	-	-	-	268.9	119	34	27.5	20	-	-	-	-	-	-	-	-	-	-	-	
25	63	252.9	129	33.7	2	-	-	-	-	-	-	-	-	-	-	-	-	-	-	-	-	-	-	-	-	-	-	-	-	-	
25	80	272.9	129	33.7	2	272.9	129	25	1.2	271.9	129	50.5	43.5	22.6	271.9	129	50.5	43.5	26	271.9	114	50.5	43.5	22.2	-	-	-	-	-	-	
32	100	328.9	161	42.4	2	-	-	-	-	-	-	-	-	-	-	-	-	-	-	-	-	-	-	-	-	-	-	-	-	-	
32	125	367.9	161	42.4	2	-	-	-	-	-	-	-	-	-	-	-	-	-	-	-	-	-	-	-	-	-	-	-	-	-	
40	100	328.9	161	48.6	2	328.9	161	38	1.2	327.9	161	50.5	43.5	35.6	327.9	161	50.5	43.5	38	327.9	140	50.5	43.5	34.9	-	-	-	-	-	-	
40	125	366.9	161	48.6	2	366.9	161	38	1.2	366.9	161	50.5	43.5	35.6	366.9	161	50.5	43.5	38	366.9	140	50.5	43.5	34.9	-	-	-	-	-	-	
50	125	373.9	192	60.3	2	373.9	192	51	1.2	372.9	192	64	56.5	48.6	372.9	192	64	56.5	50	372.9	159	64	56.5	47.6	-	-	-	-	-	-	

You can fill out the fields directly in the PDF file before printing out the form.

Valve system On/Off CLASSIC Type 8801-DB/8803-DB – request for quotation Please fill and send to your nearest Bürkert facility* with your inquiry or order

Company	Contact person
Customer no.	Department
Address	Tel./Fax
Postcode/town	E-Mail

= mandatory fields to fill out Quantity Required delivery date

Operating data

Pipeline	DN	<input type="text"/>	PN	<input type="text"/>
Pipe material	<input type="text"/>			
<input type="checkbox"/> Process medium	<input type="text"/>			
<input type="checkbox"/> Type of medium	<input type="checkbox"/> Liquid	<input type="checkbox"/> Steam	<input type="checkbox"/> Gas	
	standard	unit		
<input type="checkbox"/> Flow rate (Q, Q _N , W) ¹⁾	<input type="text"/>	<input type="text"/>		
<input type="checkbox"/> Temperature at valve inlet	<input type="text"/>	<input type="text"/>		
<input type="checkbox"/> Absolute pressure at valve inlet	<input type="text"/>	<input type="text"/>		
<input type="checkbox"/> Steam sterilisation	temperature	<input type="text"/>		

¹⁾ standard unit: Liquid Q = m³/h; Steam W = kg/h; Gas Q_N = Nm³/h

Valve features

Specification key

automatically transferred from last page

<input type="checkbox"/>	<input type="checkbox"/>	<input type="checkbox"/>	<input type="checkbox"/>	<input type="checkbox"/>	<input type="checkbox"/>	<input type="checkbox"/>	<input type="checkbox"/>	<input type="checkbox"/>
--------------------------	--------------------------	--------------------------	--------------------------	--------------------------	--------------------------	--------------------------	--------------------------	--------------------------

Surface finish (if not standard) internal μm external μm

Pilot pressure min. max.

Automation unit features

Click on the orange box „More info“... you will come to our website for the resp. product where you can download the data sheet.

Electrical position feedback

Type 8697
For actuator size 40...225



- LED position indicator
- Mechanical or inductive limit switches for end position registering
- Housing with IP65/IP67, 4X rating protection
- Optional intrinsically safe version acc. to ATEX / IECEx

Position feedback switches

- Micro switch 2 V DC
- Micro switch 50 – 225 V DC/AC
- Inductive switch 3-wire PNP
- Inductive switch 2-wire NAMUR
- Inductive switch 2-wire 2 V DC

Electrical connection

- Cable gland
- M12 connector (applicable only with inductive switch 3-wire PNP)

Number of Position feedback switches

- 2x

Approval

- ATEX cat. 3GD, IECEx
- ATEX cat. 2DG, IECEx
- without

Valve system On/Off CLASSIC Type 8801-DB – request for quotation , *continued*

Valve accessories	
Pilot valve	Stroke limitation
<input type="checkbox"/> Pilot valve	<input type="checkbox"/> Stroke limitation
Power supply <input type="text"/>	<input type="checkbox"/> Min./max. stroke limitation , with visual position indicator
	<input type="checkbox"/> Max. stroke limitation , without visual position indicator
Please specify item no. if known: <input type="text"/>	Please specify item no. if known: <input type="text"/>

Certifications
<input type="checkbox"/> Attestation of compliance with the order EN-ISO 10204 2.1 (Item no. 440788)
<input type="checkbox"/> Test report EN-ISO 10204 2.2 (Item no. 803722)
<input type="checkbox"/> Certification of Conformity for Raw Material EN-ISO 10204 3.1 (Item no. 803723)
<input type="checkbox"/> FDA - USP certificate

Comment / sketch

DTS 1000010978 EN Version: Z Status: RL (released | freigegeben | validé) printed: 11.02.2020

*To find your nearest Bürkert facility, click on the orange box → www.burkert.com

Valve features, specification key

Example

A 15 AD VG SA42 D D NO16

Specification key

Please make a choice

CONTROL FUNCTION

A	normally closed by spring action
B	normally open by spring action
I	double acting

ORIFICE (Diaphragm size) [mm]

08
15
20
25
40
50

SEAL MATERIAL

AD	EPDM
EA	PTFE/EPDM
FF	FKM
EU	advanced PTFE/EPDM in two pieces

BODY MATERIAL

Standard	VG	Cast stainless steel 316L/1.4435
----------	----	----------------------------------

VARIABLE CODES

Surface finish, internal

NO06	Mechanical polished Ra=0.8 µm
NO16	Electro polished Ra=0.6 µm

ACTUATOR SIZE¹⁾

C	Ø 40 mm
D	Ø 50 mm
E	Ø 63 mm
F	Ø 80 mm
G	Ø 100 mm
H	Ø 125 mm

¹⁾ for technical spec. see table, page 2

ACTUATOR MATERIAL

C	PA	
D	PPS	Standard



PORT CONNECTION

Welded

Port conn. [mm]	EN ISO 1127/ISO 4200	SMS 3008	DIN 11850				BS 4825	ASME BPE	JIS Sanitary	JIS Utility
			Serie 0	Serie 1	Serie 2	Serie 3				
4			SC40=6×1.0							
6			SC41=8×1.0							
8	SA40=13.5×1.6		SC42=10×1.0				SODB=6.35×1.2	SA90=6.35×0.89	SA70=13.8×1.65	
10	SA41=17.2×1.6			SF40=12×1.0	SD40=13×1.5	SE40=14×20.0	SODC=9.53×1.2	SA91=9.53×0.89	SA71=17.3×1.65	
15	SA42=21.3×1.6		SC43=18×1.5	SF41=18×1.0	SD42=19×1.5	SE42=20×2.0	SODD=12.7×1.2	SA92=12.7×1.65	SA72=21.7×2.1	
20	SA43=26.9×1.6		SC44=22×1.5	SF42=22×1.0	SD43=23×1.5	SE43=24×2.0	SODE=19.05×1.2	SA93=19.05×1.65	SA76=27.2×2.1	SA80=27.2×2.1
25	SA44=33.7×2.0	SA60=25.0×1.2	SC45=28×1.5	SF43=28×1.0	SD44=29×1.5	SE44=30×2.0	SODF=25.4×1.65	SODF=25.4×1.65	SA73=25.4×1.2	SA81=34×2.0
32	SA45=42.4×2.0		SC46=34×1.5	SF44=34×1.0	SD45=35×1.5	SE45=36×2.0				SA83=42.7×2.0
40	SA46=48.3×2.0	SA62=38.0×1.2	SC47=40×1.5	SF45=40×1.0	SD46=41×1.5	SE46=42×2.0	SODH=38.1×1.65	SODH=38.1×1.65	SA74=38.1×1.2	SA84=60.5×2.0
50	SA47=60.3×2.0	SA63=51.0×1.2	SC48=52×1.5	SF46=52×1.0	SD47=53×1.5	SE47=54×2.0	SODI=50.8×1.65	SODI=50.8×1.65	SA75=50.8×1.5	

Clamp

Port conn. [mm]	ISO 2852 SMS 3017	BS4825	DIN 32676
8	TC51=Clamp 34 - for tube ISO 4200	TG41=Clamp 25 - Rohr 9.53×1.2	
10	TC41=Clamp 34 - for tube ISO 4200	TH42=Clamp 25 - Rohr 12.7×1.2	TD41=Clamp 34 - Tube 13×1.5
15	TC42=Clamp 34 - for tube ISO 4200	TH43=Clamp 25 - Rohr 19.05×1.2	TD42=Clamp 34 - Tube 19×1.5
20	TC43=Clamp 50.5 - for tube ISO 4200		TD43=Clamp 34 - Tube 23×1.5
25	TC44=Clamp 50.5 - for tube ISO 4200	TG44=Clamp 50.5 - Rohr 25.4×1.65	TD44=Clamp 50.5 - Tube 29×1.5
40	TC46=Clamp 64 - for tube ISO 4200	TG45=Clamp 50.5 - Rohr 38.1×1.65	TD46=Clamp 50.5 - Tube 41×1.5
50	TC47=Clamp 77.5 - for tube ISO 4200	TG46=Clamp 64 - Rohr 50.8×1.65	TD47=Clamp 64 - Tube 53×1.5

In case of special application conditions, please consult for advice.

Subject to alterations
© Christian Bürkert GmbH & Co. KG

1802/22_EU-en_00891675